

TFT COLOR LCD MODULE

NL10276AC28-01L

**36 cm (14.1 inches), 1024 × 768 pixels, fullcolor,
multiscan function, built-in CRT interface board**

DESCRIPTION

The NL10276AC28-01L is a TFT (thin film transistor) active-matrix color liquid crystal display (LCD) comprising an amorphous silicon TFT attached to each signal electrode, a driving circuit, a CRT interface board, and a backlight. NL10276AC28-01L has a built-in backlight with an inverter.

The 36 cm (14.1 inch) diagonal display area contains 1024 × 768 pixels and can display fullcolor (more than 16 million colors simultaneously). Also, it has a wide viewing angle and multiscan function.

FEATURES

- High luminance (200 cd/m² typ.)
 - Low reflection
 - CRT interface board
 - Auto recognition of input signal:
 - Analog RGB signals, synchronous signals (Hsync, Vsyn, composite)
 - Digital control: e.g., brightness, display position
 - Free supply voltage sequence
 - Corresponds to DDC1 and DDC2B
 - Corresponds to VESA DPMS
 - Multiscan function: e.g., XGA, SVGA, VGA, VGA-TEXT, MAC
 - Incorporated edge-type backlight (two lamps into two lamp holders, inverter)
 - Lamp unit replaceable
- (note)
- VESA: Video Electronics Standards Association
 - DPMS: Display Power Management Signaling
 - DDC1: Display Data Channel 1
 - DDC2B: Display Data Channel 2B

APPLICATIONS

- Desktop PCs
- Engineering workstations
- Display terminals for control systems
- Monitors for process controllers

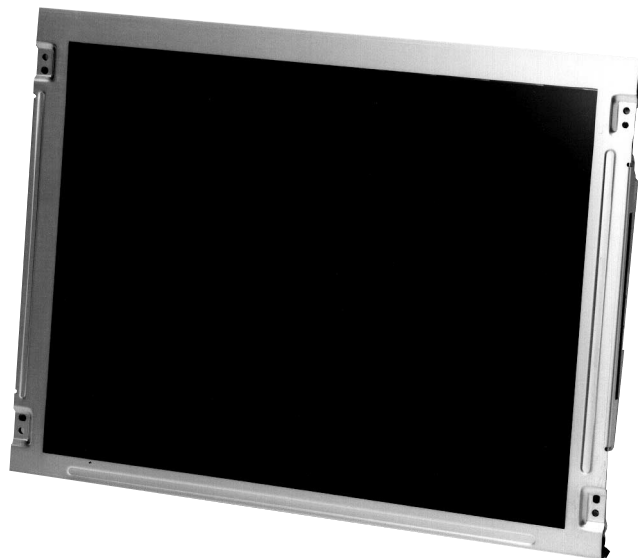

On-Screen Display (OSD)

Application with the OSD function might conflict with patents in Europe and/or the U.S.A.

If you apply the OSD function, please do so in accordance with the patent regulations of your location.

The information in this document is subject to change without notice.
Please confirm the delivery specification before starting to design your system.

STRUCTURE AND FUNCTION

A color TFT (thin film transistor) LCD module is comprised of a TFT liquid crystal panel structure, LSIs for driving the TFT array, and a backlight assembly. The TFT panel structure is created by sandwiching liquid crystal material in the narrow gap between a TFT array glass substrate and a color filter glass substrate. After the driver LSIs are connected to the panel, the backlight assembly is attached to the back side of the panel.

RGB (red, green, blue) data signals from a source system are modulated into a form suitable for active-matrix addressing by the onboard signal processor and sent to the driver LSIs, which in turn address the individual TFT cells.

Acting as an electro-optical switch, each TFT cell regulates light transmission from the backlight assembly when activated by the data source. By regulating the amount of light passing through the array of red, green, and blue dots, color images are created with clarity.

CHARACTERISTICS (at room temperature)

Item	Description
Display area	285.696 (H) × 214.272 (V) mm
Drive system	a-Si TFT active matrix
Display colors	Fullcolor
Number of pixels	1024 (H) × 768 (V)
Pixel arrangement	RGB vertical stripe
Pixel pitch	0.279 (H) × 0.279 (V) mm
Module size	330.0 (H) × 255.0 (V) × 19.8 (D) mm (typ.)
Weight	1230 g (typ.)
Contrast ratio	150:1 (typ.)
Viewing angle (more than the contrast ratio of 10:1)	<ul style="list-style-type: none"> Horizontal: 50° (typ., left side, right side) Vertical: 20° (typ., up side), 35° (typ., down side)
Designed viewing direction	<ul style="list-style-type: none"> Optimum gray-scale ($\gamma = 2.2$): perpendicular Wider viewing angle with contrast ratio: down side (6 o'clock) Wider viewing angle without image reversal: up side (12 o'clock)
Color gamut	40% (typ., at center, to NTSC)
Response time	11 ms (typ.), "white 100%" to "black 10%"
Luminance	200 cd/m ² (typ.)
Input signals	Analog RGB signals, synchronous signals (Hsync and Vsync or composite)
Backlight	Edge light type: two cold cathode fluorescent lamps with an inverter Lamp holder: 141LHS08 Inverter: 141PW111
Supply voltage	12 V, 12 V (logic/LCD driving, backlight)
Power consumption	16.0 W (typ.)

BLOCK DIAGRAM

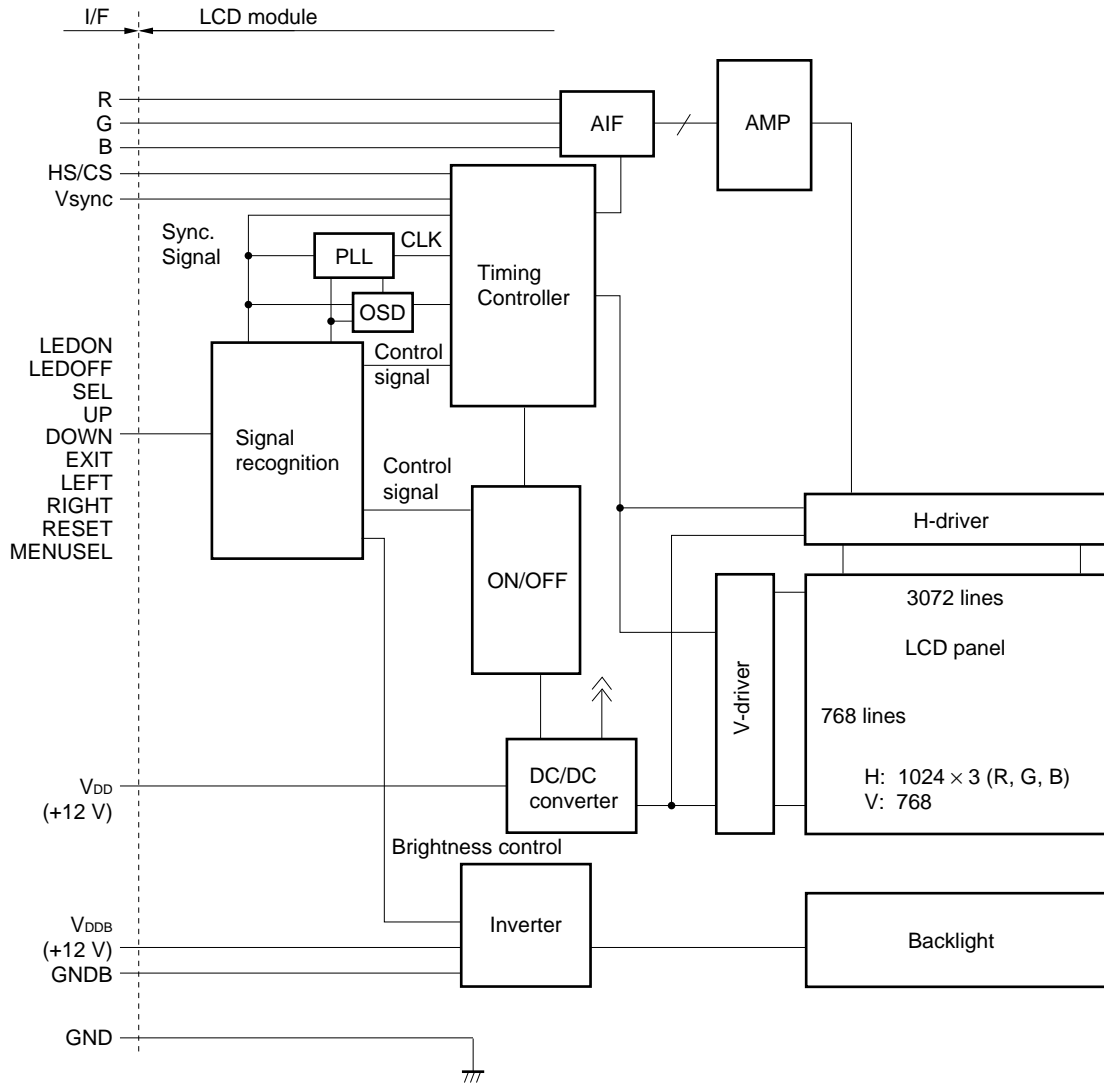

HS: Hsync

CS: Composite synchronous signal

Note: Neither GND nor GNDB is connected to frame. These should be connected in customers' equipment.

GENERAL SPECIFICATIONS

Item	Description	Unit
Module size	330 ± 0.5 (H) × 255.0 ± 0.5 (V) × 20.5 (max.) (D)	mm
Display area	285.696 (H) × 214.272 (V)	mm
Number of dots	1024 × 3 (H) × 768 (V)	dots
Pixel pitch	0.279 (H) × 0.279 (V)	mm
Dot pitch	0.093 (H) × 0.279 (V)	mm
Pixel arrangement	RGB (red, green, blue) vertical stripe	–
Display colors	Full color	color
Weight	1230 (typ.) 1350 (max.)	g

ABSOLUTE MAXIMUM RATINGS

Parameter	Symbol	Rating	Unit	Remarks	
Supply voltage	V _{DD}	–0.3 to + 14	V	T _a = 25°C	
	V _{DDB}	–0.3 to + 14	V		
Logic input voltage	V _{In1}	–0.3 to + 5.5	V	T _a = 25°C V _{DD} = 12 V	
R,G,B input voltage	V _{In2}	–6.0 to + 6.0	V		
Storage temp.	T _{st}	–20 to + 60	°C	–	
Operating temp.	T _{op}	0 to 50	°C	Module surface Note	
Relative humidity (RH)		≤ 95%	%	T _a ≤ 40°C	No condensation
		≤ 85%		40 < T _a ≤ 50°C	
Absolute humidity	Absolute humidity shall not exceed T _a = 50°C, RH = 85%.		g/m ³	T _a > 50°C	

Note: Measured at the LCD panel (including self-heat.)

ELECTRICAL CHARACTERISTICS

(1) Logic, LCD Driving, Backlight

(T_a = 25°C)

Item	Symbol	Min.	Typ.	Max.	Unit	Remarks
Supply voltage	V _{DD}	11.4	12.0	12.6	V	Logic and LCD driving
	V _{DDB}	11.4	12.0	12.6	V	Backlight
Logic input "L" voltage	V _{IL}	0	–	0.8	V	HS/CS, Vsync, UP, DOWN, SEL, RESET, EXIT, RIGHT, LEFT, DDCCLK, DDCDAT
Logic input "H" voltage	V _{IH}	2.2	–	5.25	V	
Logic output "L" voltage	V _{OL}	–	–	0.4	V	DDCDAT
Logic output "H" voltage	V _{OH}	2.4	–	–	V	
Logic input "L" current	I _{IL}	–1	–	–	μA	HS/CS, Vsync
Logic input "H" current	I _{IH}	–	–	1	μA	
Logic output "L" current 1	I _{OL1}	–	–	100	μA	DDCDAT
Logic output "H" current 1	I _{OH1}	–100	–	–	μA	
Supply current (Pixel checked pattern)	I _{DD}	–	630	900	mA	V _{DD} = 12.0 V
		–	170	200	mA	Power-saving mode V _{DD} = 12.0 V
	I _{DDB}	–	700	900	mA	V _{DDB} = 12.0 V (Max. luminance)
		–	0.3	10	mA	Power-saving mode V _{DDB} = 12.0 V

(2) Video Signal (R, G, B) Input

(T_a = 25°C)

Item	Min.	Typ.	Max.	Unit	Remarks
Maximum amplitude (white–black)	0 (black)	0.7 (white)	*A	V p-p	Note
DC input level (black)	–0.5	–	+2.5	V	–
Sync level	–0.2	0.3	*B (0.6)	V p-p	G terminal (sync on green)
*A + *B	–	–	1.4	V p-p	–

Note: Contrast adjustment is needed if the amplitude exceeds 0.7 V p-p.

POWER SUPPLY DESIGN

- (1) Please note that the supply voltage must not be applied to the module while the control signals (SEL, UP, DOWN, EXIT, LEFT, RIGHT, and RESET) are connected to GND. Otherwise, the module may malfunction.
- (2) If the power supply voltage is applied while UP and DOWN are connected to GND, the input control signals become ineffective. To reset this mode, turn off the power once and then turn on the power while UP and DOWN are connected to GND. The mode will then be released.
- (3) Do not change the MENSEL setting while the module is being operated.
MENSEL selection (hierarchical type or toggle type) is set when the power supply voltage is applied.

(4) Inverter current wave

The inverter current wave is as follows.

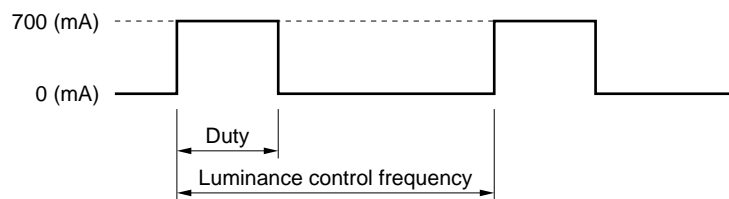

Maximum luminance control: 100% (Duty)
 Minimum luminance control: 20% (Duty)
 $\text{Luminance control frequency} \approx \text{Input Vsync frequency} \times K$
 Input Vsync frequency \leq 75 Hz: $K = 4.6$
 Input Vsync frequency $>$ 75 Hz: $K = 3.6$

(5) Ripple of supply voltage

Please note that the ripple at the input connector of the module should be within the values shown in this table. If the ripple is beyond these values, the noise may appear on the screen.

Supply voltage	V _{DD} (for logic and LCD driver)	V _{DDB} (for backlight)
Acceptable range	$\leq 100 \text{ mV p-p}$	$\leq 200 \text{ mV p-p}$

Note: The acceptable range of ripple voltage includes spike noise.

Example of the power supply connection

a) Separate the power supply

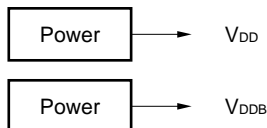

b) Put in the filter

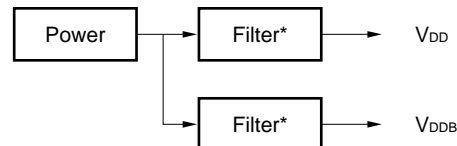

Filter* (reference value)
 $L = 10 \mu\text{H to } 100 \mu\text{H}$
 $C = 10 \mu\text{F to } 100 \mu\text{F}$

INTERFACE AND CONNECTOR PIN ASSIGNMENT

(1) Logic and LCD Driving

CN1

Part No.: 1-353119-4
 Adaptable socket: 1-353068-4
 Supplier: Japan AMP, Ltd.

Pin No.	Symbol	Pin No.	Symbol
1	B	8	Vsync
2	GND	9	GND
3	G	10	HS/CS
4	GND	11	GND
5	R	12	DDCCLK
6	GND	13	N.C.
7	GND	14▼	DDCDAT

Figure from socket view

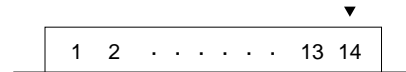

Note: N.C. (No connection) must be open.

CN3

Part No.: DF14A-25P-1.25H
 Adaptable socket: DF14-25S-1.25C
 Supplier: Hirose Electric Co., Ltd.

Pin No.	Symbol	Pin No.	Symbol
1▼	LEDON	14	EXIT
2	LEDOFF	15	GND
3	GND	16	N.C.
4	N.C.	17	GND
5	N.C.	18	GND
6	RIGHT	19	MENUSEL
7	LEFT	20	N.C.
8	RESET	21	N.C.
9	N.C.	22	N.C.
10	GND	23	GND
11	SEL	24	N.C.
12	UP	25	N.C.
13	DOWN		

Figure from socket view

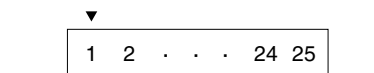

Note: N.C. (No connection) must be open.

CN5

Part No.: IL-Z-8PL-SMTY

Adaptable socket: IL-Z-8S-S125C3

Supplier: Japan Aviation Electronics Industry, Limited (JAE)

Pin No.	Symbol	Pin No.	Symbol
1	V _{DD}	5	GND
2	V _{DD}	6	GND
3	V _{DD}	7	GND
4	V _{DD}	8▼	GND

Figure from socket view

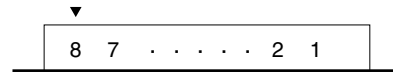

(2) Backlight

CN201

Part No.: IL-Z-11PL1-SMTY

Adaptable socket: IL-Z-11S-S125C3

Supplier: Japan Aviation Electronics Industry, Limited (JAE)

Pin No.	Symbol	Pin No.	Symbol
1	V _{DDB}	7	N.C.
2	V _{DDB}	8	N.C.
3	V _{DDB}	9	N.C.
4	GNDB	10	N.C.
5	GNDB	11▼	N.C.
6	GNDB		

Figure from socket view

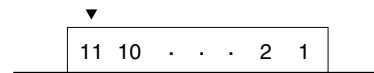

Note: N.C. (No connection) must be open.

Rear view

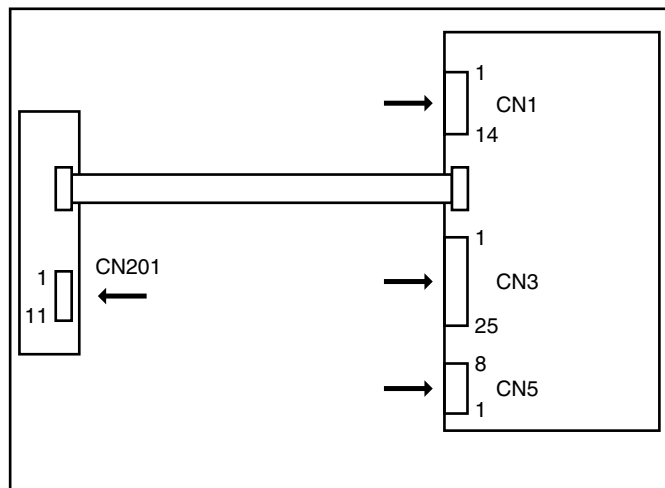

(3) Pin Function

Symbol	I/O	Logic	Description
HS/CS	Input	Negative	Horizontal synchronous signal input or composite synchronous signal input (TTL level), positive/negative auto recognition
Vsync	Input	Negative	Vertical synchronous signal input (TTL level), positive/negative auto recognition, clock input for DDC1
R	Input	–	Red video signal input (0.7 Vp-p, input impedance 75 Ω)
G	Input	–	Green video signal input (0.7 Vp-p, input impedance 75 Ω)
B	Input	–	Blue video signal input (0.7 Vp-p, input impedance 75 Ω)
LEDON	Output	Positive	Indicator for LED power on “H”: LED select; “L”: Other status
LEDOFF	Output	Positive	Indicator for power save mode “H”: Power mode select; “L”: Other status
DDCCLK	Input	Positive	CLK for DDC2B
DDCDAT	Input/ Output	Positive	Data for DDC1/2B read/write
SEL	Input	Negative	Control function select signal (TTL level) SEL is pulled up in the module. Details of the functions are mentioned in CONTROL FUNCTIONS , page 13. “H” or “open”: SEL off; “L”: SEL on
UP	Input	Negative	Control signal (TTL level) The signal increases the value of the functions selected. UP is pulled up in the module. “H” or “open”: UP off; “L”: UP on
DOWN	Input	Negative	Control signal (TTL level) The signal decreases the value of the functions selected. DOWN is pulled up in the module. “H” or “open”: DOWN off; “L”: DOWN on
EXIT	Input	Negative	Control function exit signal (TTL level) EXIT is pulled up in the module. “H” or “open”: EXIT off; “L”: EXIT on
RIGHT ^{Note 1}	Input	Negative	Control signal (TTL level) The signal increases the value of the functions selected. RIGHT is pulled up in the module. “H” or “open”: RIGHT off; “L”: RIGHT on
LEFT ^{Note 1}	Input	Negative	Control signal (TTL level) The signal decreases the value of the functions selected. LEFT is pulled up in the module. “H” or “open”: LEFT off; “L”: LEFT on
RESET ^{Note 1}	Input	Negative	Control signal (TTL level) The signal initializes the selected function. RESET is pulled up in the module. “H” or “open”: RESET off; “L”: RESET on
MENUSEL	Input	–	OSD design select signal (TTL level) MENUSEL is pulled up in the module. “H or open”: Hierarchical type “L”: Toggle type For details, see page 10, OSD Menu Select .

Symbol	I/O	Logic	Description
V _{DD}	–	–	Power supply for logic and LCD driving +12 V (±5%)
V _{DDB}	–	–	Power supply for backlight +12 V (±5%)
GND	–	–	Ground for system
GNDB	–	–	Ground for backlight

- Notes:**
1. This terminal becomes effective only when the value of Button Sel is 7.
Details of the functions are given on page 27, **Initial Value Change Functions**.
 2. Grounds for system (GND) and backlight (GNDB) are not connected in the module.
 3. The 12 V for the backlight should be started up within 300 ms; otherwise, the protection circuit makes the backlight turn off.

(4) OSD Menu Select

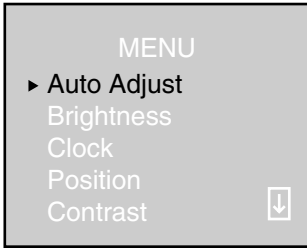
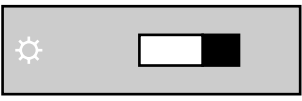
OSD Menu Type	Hierarchical Type	Toggle Type
MENUSEL	“H” or “open”	“L”
How to adjust	For details, see page 27, Initial Value Change Functions . 	For details, see page 27, Initial Value Change Functions . 

- Notes:**
1. If the OSD menu type is changed, the adjustment of the type becomes a default value.
Then, it takes 5 seconds to display the changed menu after the supply voltage is input again.
Indicators for both LEDON and LEDOFF are “ON” at one time during the 5 seconds.
 2. The initial value of the contrast ratio is as follows.
Hierarchical type : 128:1 (typ.)
Toggle type : 100:1 (typ.)
 3. On-screen Display (OSD)
Application with the OSD function might conflict with patents in Europe and/or the U.S.A.
If you apply the OSD function, please do so in accordance with the patent regulations of your location.

(5) Equivalent circuit

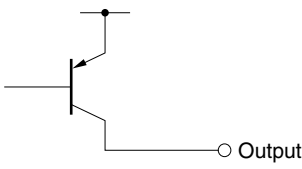
Symbol	I/O	Equivalent Circuit
LEDON LEDOFF	Output	RN2306 (Toshiba) Or equivalent 

Example of LED circuit

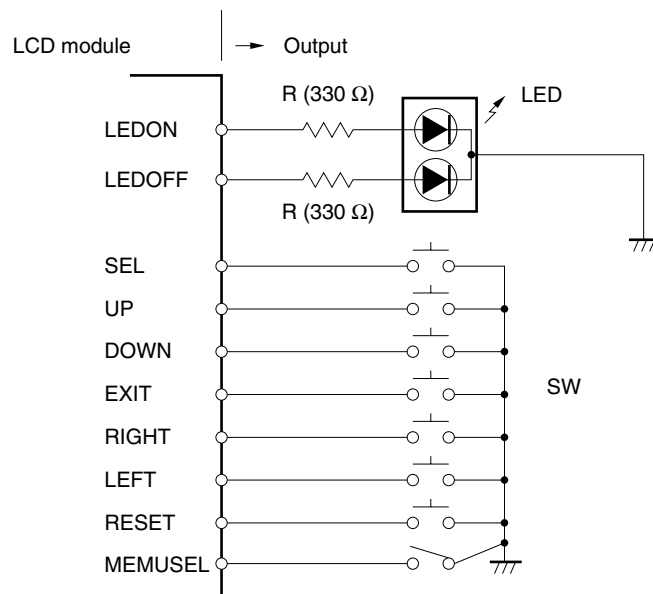

INPUT SIGNALS

(1) Synchronous Signal

This module is corresponding to the synchronous signals below.

Auto Recognition Mode	Synchronous Signal		
	HS/CS	Vsync	Sync on Green
Separate synchronous signal mode (HS, Vsync)	Input	Input	Input or no input
Composite synchronous mode	Input (cs)	No input	Input or no input
Sync on Green mode	No input	No input	Input
Power-saving mode	Input (HS)	No input	Input or no input
	No input	Input	Input or no input
	No Input	No input	No input

Notes: 1. Power-saving mode corresponds to VESA DPMA.

2. The module recognizes the Sync on Green signal automatically, when the FUNC in SOG Sel of Sel Data is "Y". Refer to Page 27 **Initial Value Change Functions**.

In case of Sync on Green mode, input signals (R, G, B, Sync on Green) must be inputted before power on.

(2) Preset Timing

The 14 types of display timing shown below are preset in this module. The input synchronous signals are automatically recognized.

Preset No.	Display Size	Vsync (Hz)	Hsync (kHz)	System CLK (MHz)	V Pulse (H)	V B. Porch (H)	H Pulse (CLK)	H B. Porch (CLK)	Sync Logic V, H	Remarks
1	640 × 400	56.432	24.830	21.053	8	25	96	48	-, -	Note 1
2	640 × 480	59.992	31.469	25.175	2	33	96	48	-, -	VGA
3	720 × 400	70.087	31.469	28.322	2	35	108	45	+, -	VGA TXT
4	800 × 600	60.317	37.879	40.000	4	23	128	88	+, +	VESA
5	640 × 480	66.667	35.000	30.240	3	39	64	96	S on G	Macintosh
6	640 × 480	75.000	37.500	31.500	3	16	64	120	-, -	VESA
7	720 × 400	85.039	37.927	35.500	3	42	36	144	+, -	VESA
8	640 × 480	85.008	43.269	36.000	3	25	48	112	-, -	Note 1
9	1024 × 768	60.004	48.363	65.000	6	29	136	160	-, -	VESA
10	800 × 600	75.000	46.875	49.500	3	21	80	160	+, +	VESA
11	832 × 624	74.565	49.735	57.283	3	39	64	224	S on G	Macintosh
12	800 × 600	85.061	53.674	56.250	3	27	64	152	+, +	Note 1
13	1024 × 768	70.069	56.476	75.000	6	29	136	144	+, +	VESA
14	1024 × 768	75.029	60.023	78.750	3	28	96	176	+, +	VESA

- Notes:**
1. Out of specification.
 2. Even if the preset timing is entered, a little adjustment of the functions such as horizontal period, CLK delay, and display position is required. The adjusted values are memorized in every preset number.
 3. This module recognizes the synchronous signals with near preset timing of the frequency of HS, Vsync, even if signals other than the preset timing were entered. For instance, the module shows the display with presetting number 6 in the case of the following conditions: 640 × 480 dot; HS: 37.861 kHz; Vsync: 72.809 Hz. Please note that using other than the preset timings may cause incorrect magnification ratios, unfitness of control functions, or other display problems.
 4. The display color scale may be different between Sync on Green input and the others.

CONTROL FUNCTIONS

(1) Expansion Modes

Expansion mode is a function by which to expand the screen size in different resolutions. For example, the VGA signal has 640 × 480 pixels. But if the display data can be expanded to 1.6 times vertically and horizontally, the VGA screen image can be displayed fully on a screen with XGA resolution.

This module automatically recognizes the timing shown in **Preset Timing** as an expansion mode.

Please adopt this mode after evaluating display quality, because the appearance in expansion mode may degrade in some cases.

The following table shows display magnifications for each mode.

Input Display	Number of Pixels	Magnification	
		Vertical	Horizontal
XGA	1024 × 768	1.0	1.0
SVGA	800 × 600	1.25	1.25
VGA	640 × 480	1.6	1.6
VGA text	720 × 400	1.92 / 1.6 hierarchical/toggle	1.42
MAC	832 × 624	1.2	1.2

Display Image

(a) SVGA mode (800 × 600)

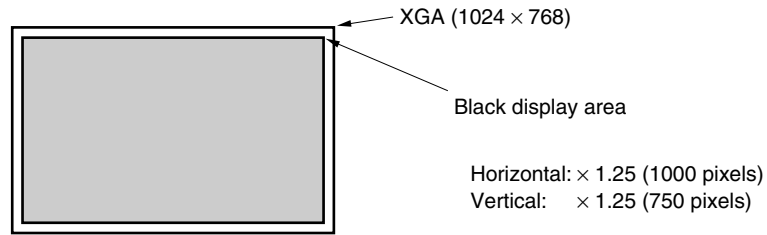

(b) VGA mode (640 × 480)

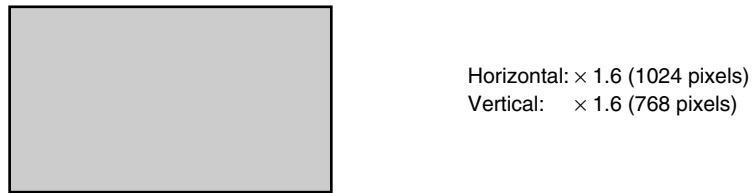

(c) VGA text mode (720 × 400)

(i) Hierarchical type

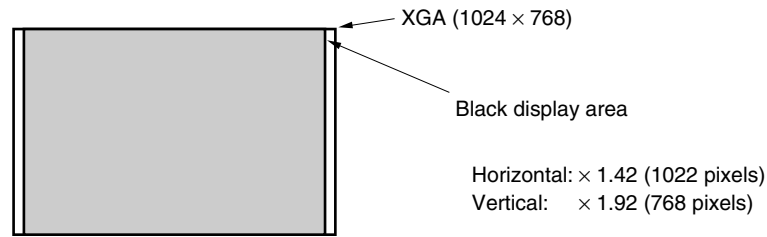

(ii) Hierarchical type

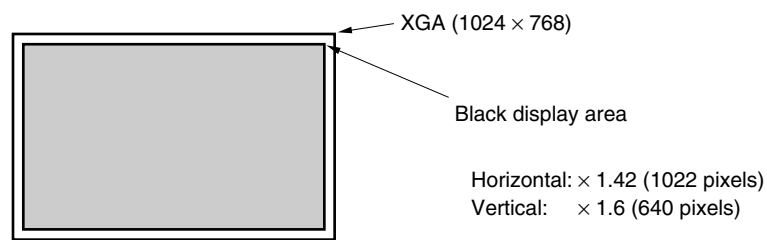

(d) 832 × 624 MAC mode (832 × 624)

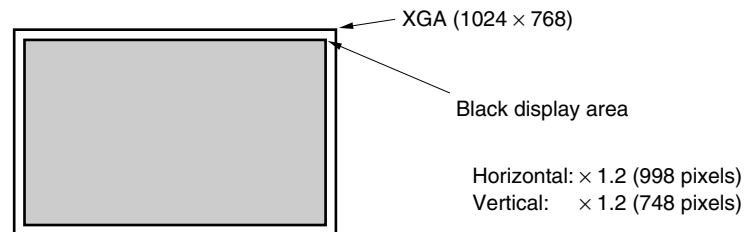

(2) DDC Function

This function corresponds to VESA DDC™ and EDID™ (Structure Version 1).

Follow the specifications of the IC when you write data. Then VCLK should be fixed on “H.”

Please write data into the necessary addresses in advance when you use this function. Data “55H” in address “00H” and “FFH” in other address have already been programmed upon shipping. The input equivalent circuit diagram is as follows.

EDID: Extended Display Identification Data

Internal circuit diagram

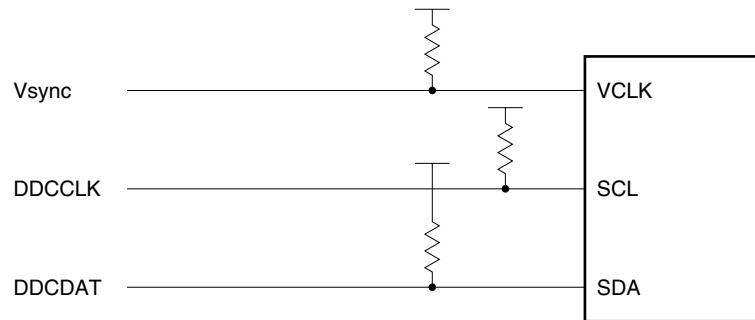

Product: Microchip Technology, Inc.
24LC21
or equivalent

(3) DPMS

This function corresponds to the VESA DPMS™ standard.

VESA DPMS Standard					NL10276AC28-01L		
State	Signal			Power Saving	Recovery Time	Power Saving	Recovery Time
	Horizontal	Vertical	Video				
On	Pulses	Pulses	Active	None	Not applicable	None	Not applicable
Standby	No pulses	Pulses	Blanked	Minimum	Short	Maximum	Short
Suspend	Pulses	No pulses	Blanked	Substantial	Longer	Maximum	Short
Off	No pulses	No pulses	Blanked	Maximum	System dependent	Maximum	Short

Note. The power consumption of the power saving mode is difference Sync on Green and others.

The power consumption of Sync. on Green is higher than others because of synchronous separation circuit.

(4) Control Function Items

No.	Form	Function Items	
1	Auto adjust	Clock and position auto adjust	
2	Brightness	Brightness of backlight control	
3	Clock	H. Size	Horizontal display period adjust
		Clock Phase	CLK phase adjust
4	Position	H. Position	Horizontal position adjust
		V. Position	Vertical position adjust
5	Contrast	W, R, G, B	White level of video signals; synchronous color and each color are controllable.
		W	White level of video signal synchronous color control
6	Color Level	W, R, G, B	Color level of video signals; synchronous color and each color are controllable.
		W	Color level of video signal synchronous color control
7	Information	Video signal information Display multiscan function, Hsync and Vsync frequency	
8	OSD Position	OSD position adjust The display position of OSD can be moved.	
9	Config	Sync on Green signal. Response or nonresponse to Sync on Green signal is selected. When nonresponse is selected (see page 27, Initial Value Change Functions), config is not displayed.	
10	All Reset	Reset to initial value. The values in No. 1 to No. 6, No. 8, and No. 9 are returned to the initial values.	

Remark 1: ① In order to achieve the best picture quality, the above functions should be adjusted by setting SEL, UP, DOWN, LEFT, RIGHT, RESET and EXIT signals.
And Clock and Position adjusted value are memorized every display mode.

② The memorized values are not affected even if the power is switched off. But the selected value is not memorized in case that a selected mode is changed to another one.

Remark 2: The Auto adjusted value may not be optimal value for the best picture quality on customer equipment and display screens. And the Auto adjust function does not work correctly when both Sync On Green signal and separate synchronous signals are inputted in this module. In those cases, please adjust each value (Clock and Position).

Remark 3: The display Image on the screen may be disturbed for a moment when each adjusted value is changed.

(5) Control Function Flowchart

(a) Hierarchical type (4 switches used for adjustment: SEL; UP; DOWN; EXIT)

For details, see page 27, Initial Value Change Functions – 6. Sel Data, Button Sel.

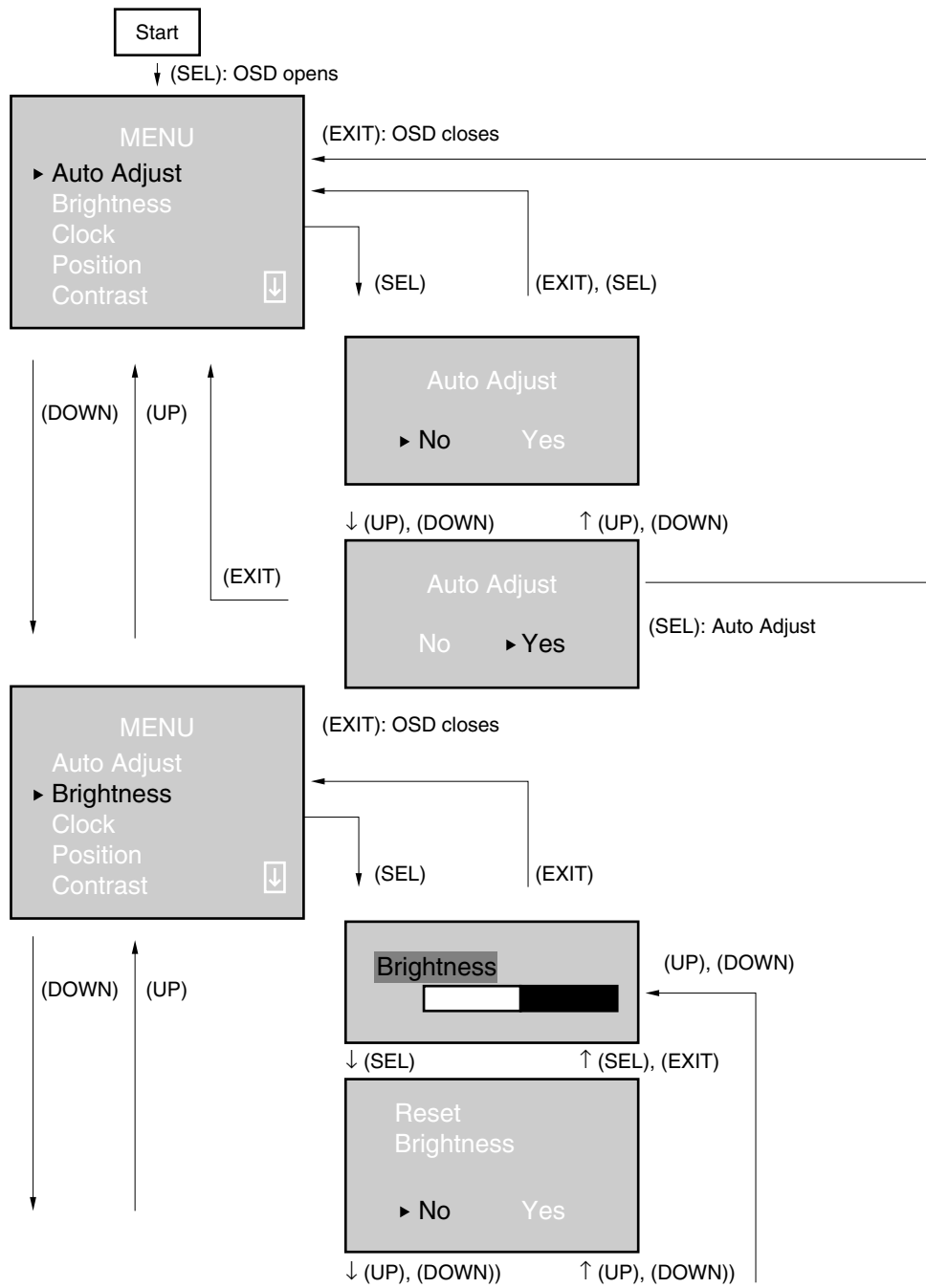

Continued on next page

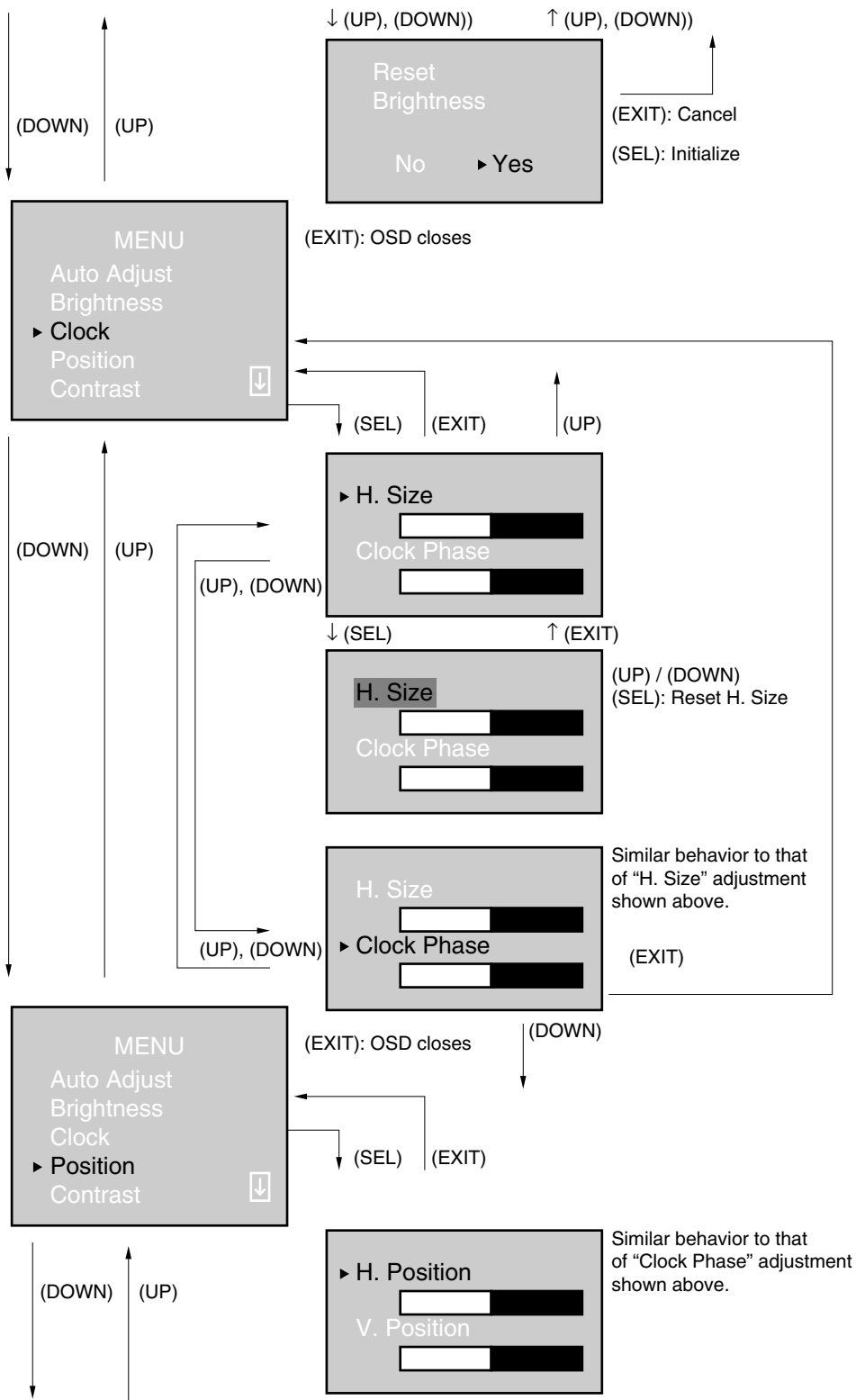

Continued on next page

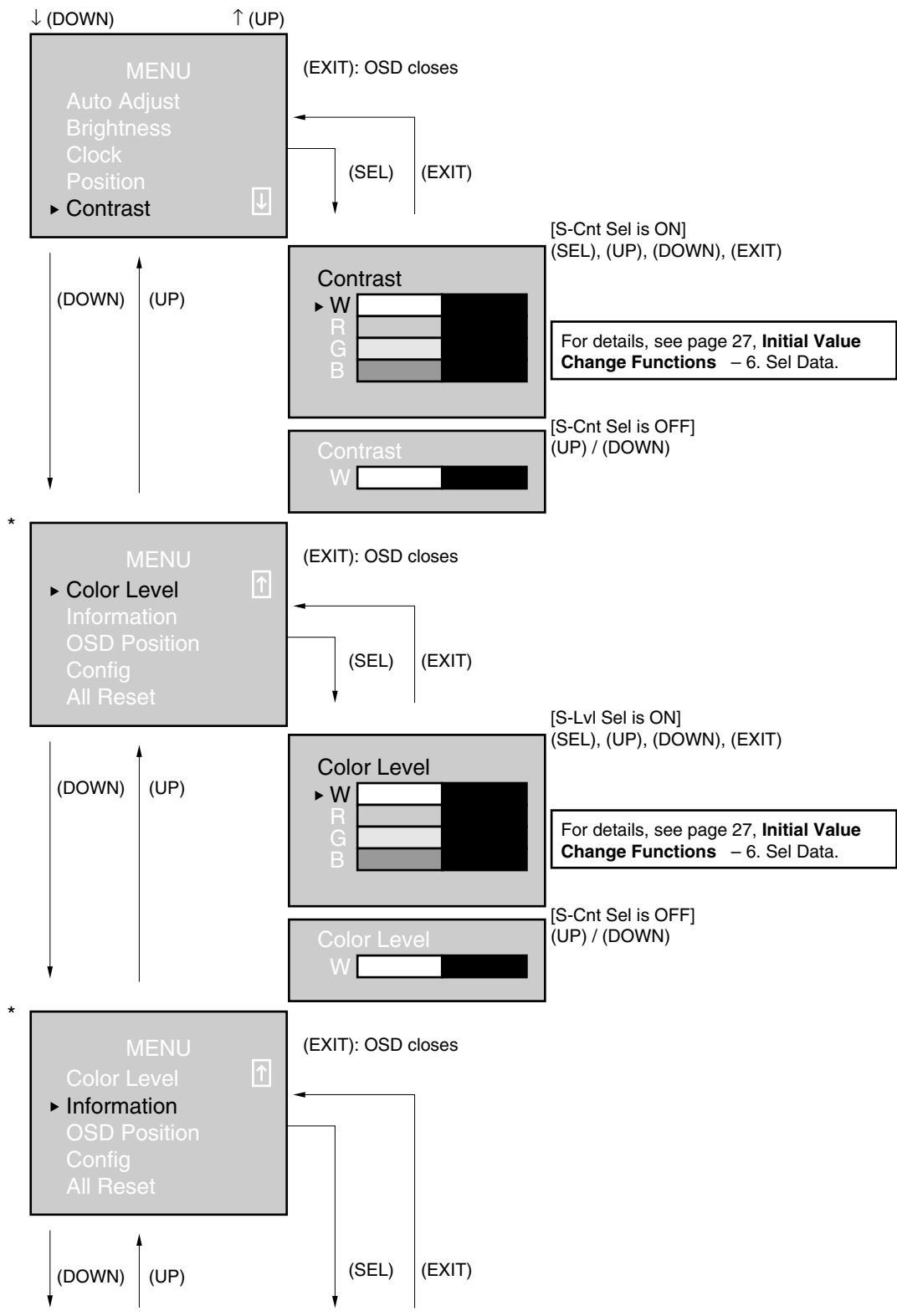

Continued on next page

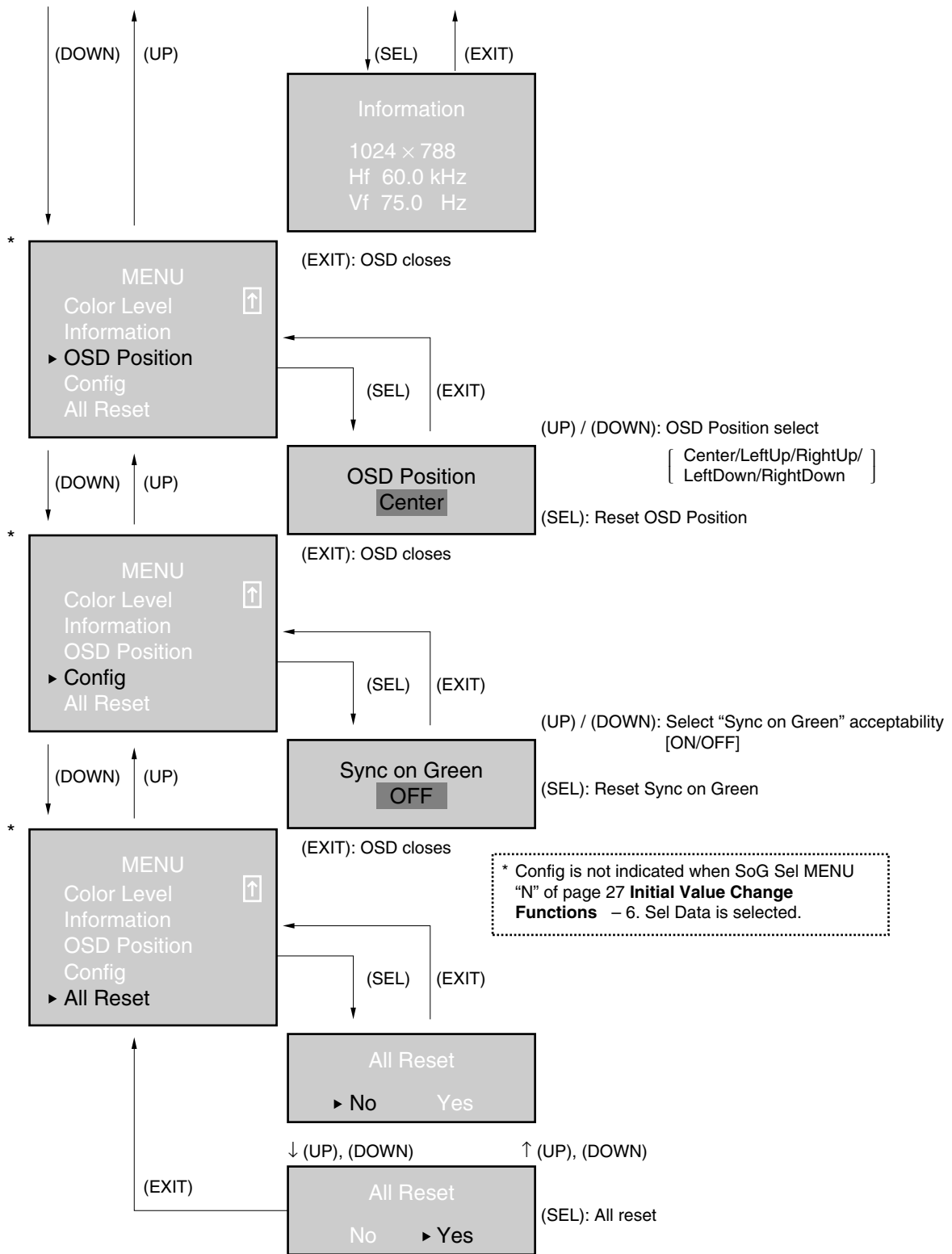

(b) Hierarchical type (7 switches used for adjustment: SEL; UP; DOWN; EXIT; LEFT; RIGHT; RESET)

For details, see page 27, **Initial Value Change Functions** – 6. Sel Data, Button Sel.

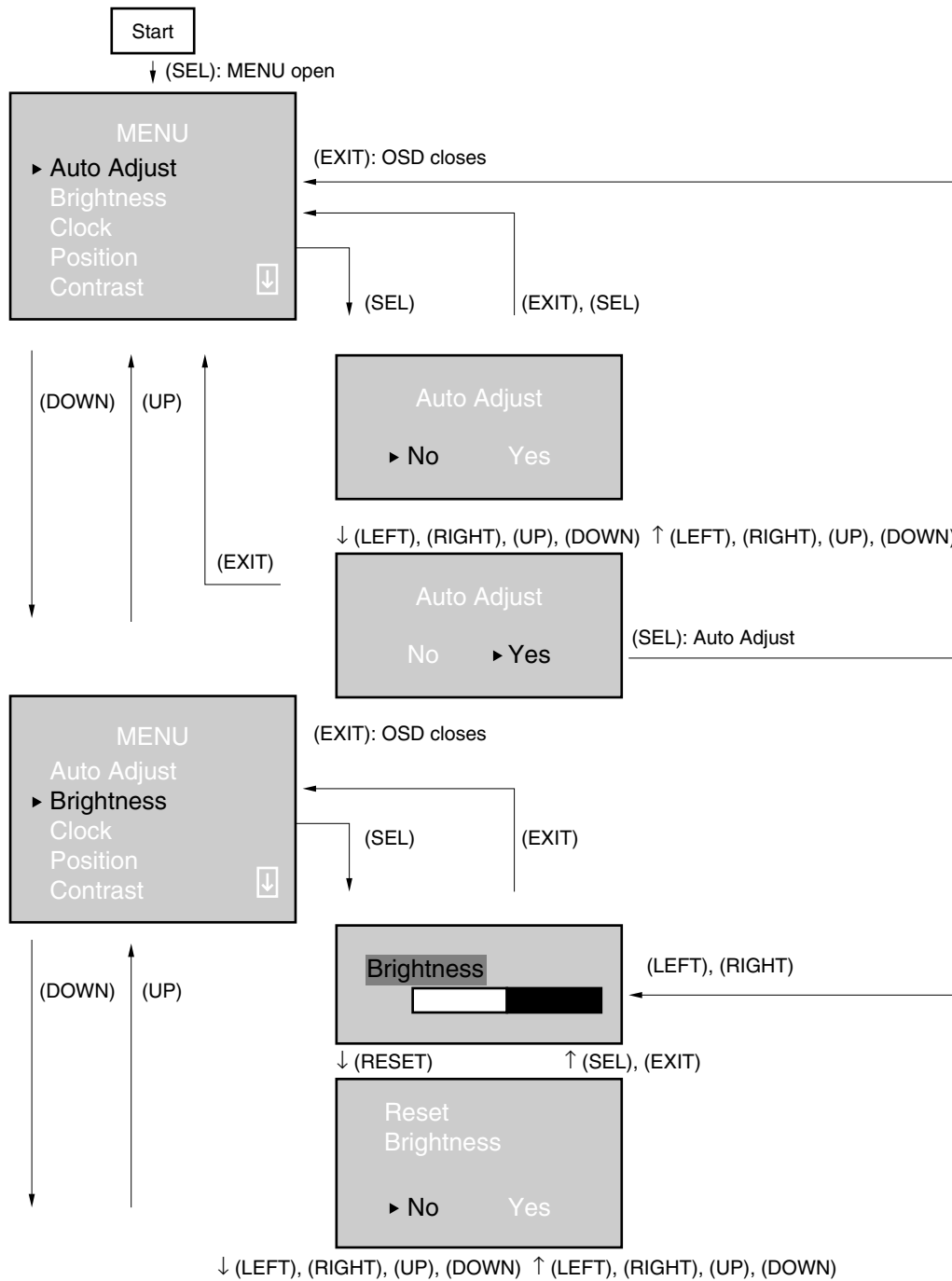

Continued on next page

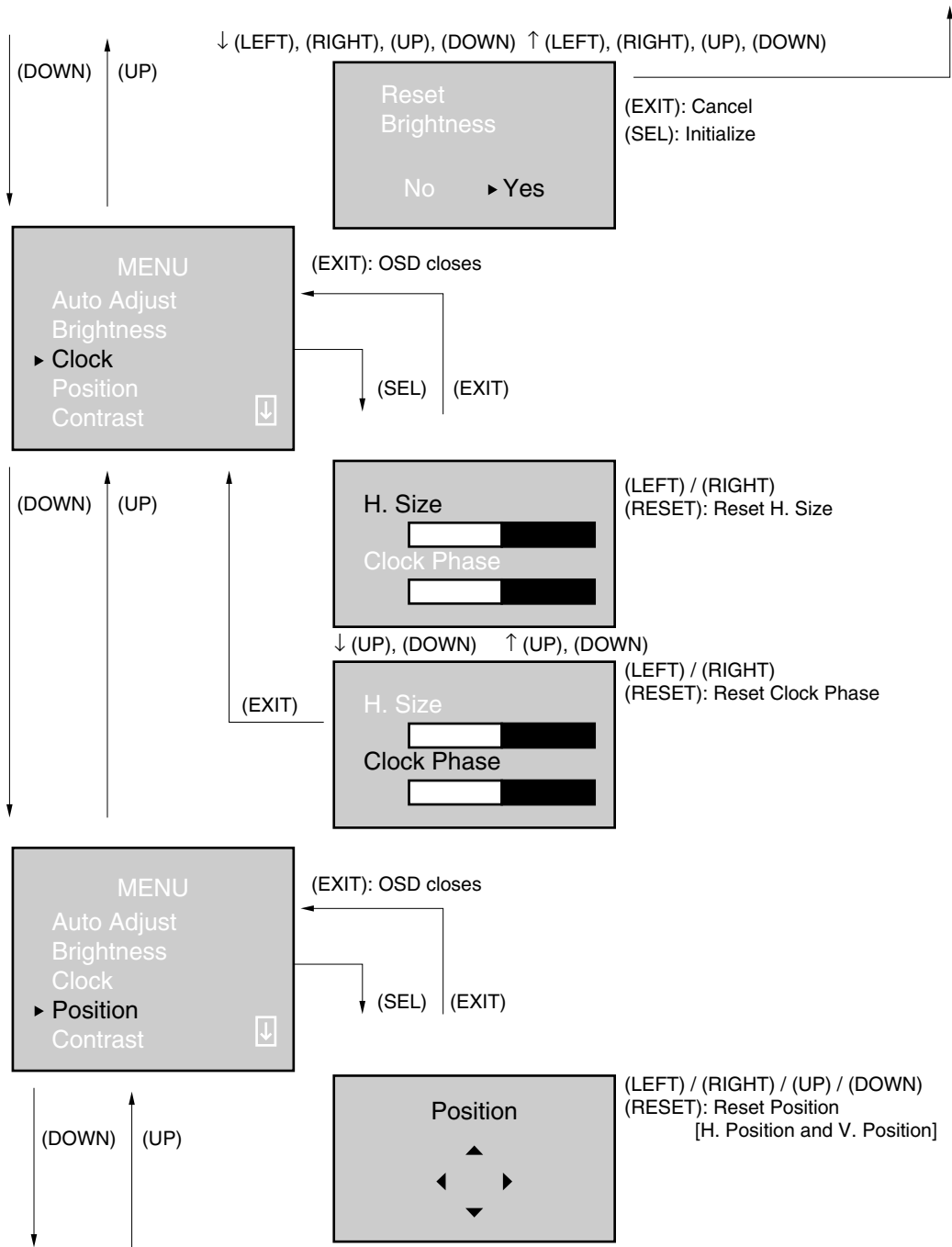

Continued on next page

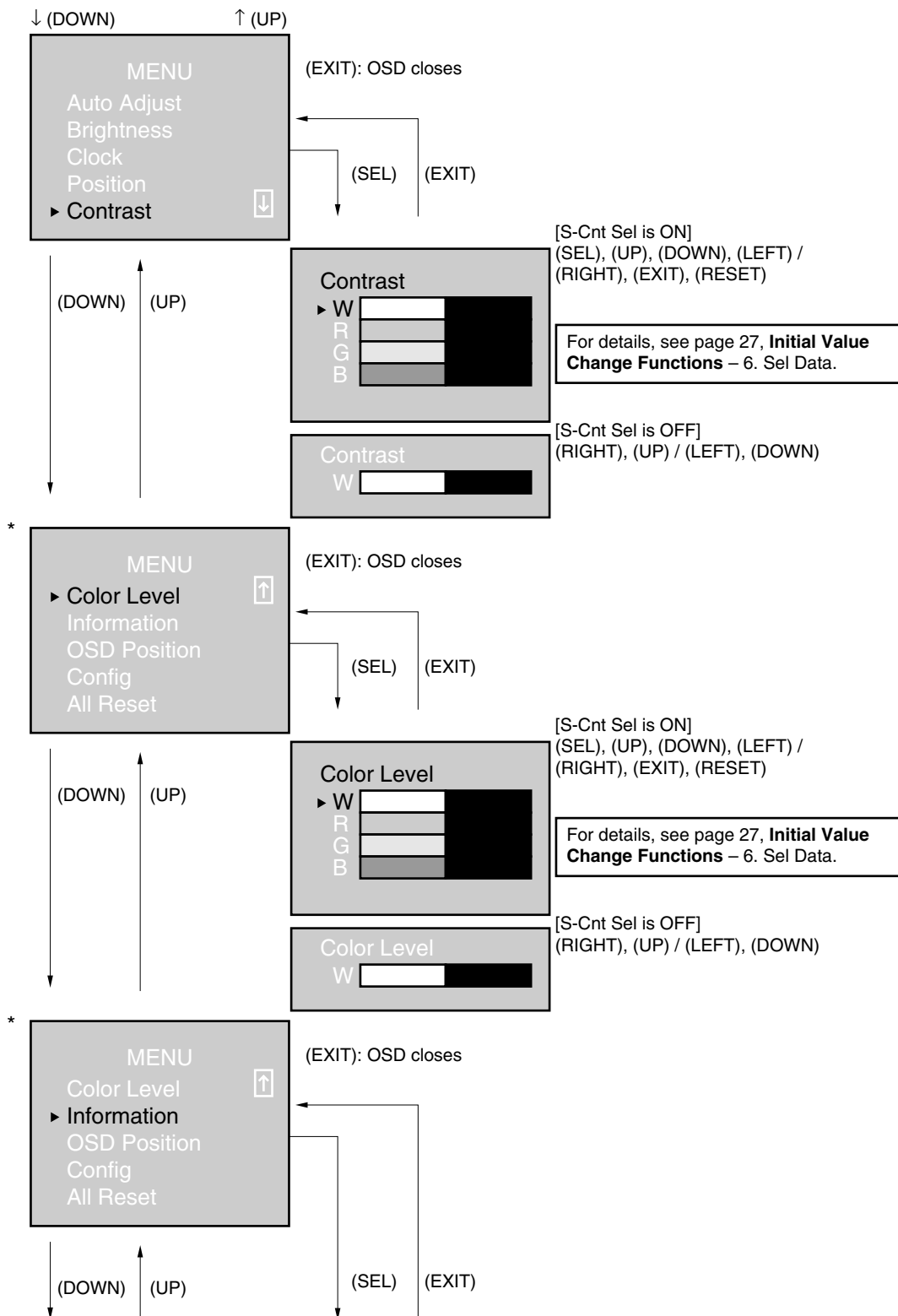

Continued on next page

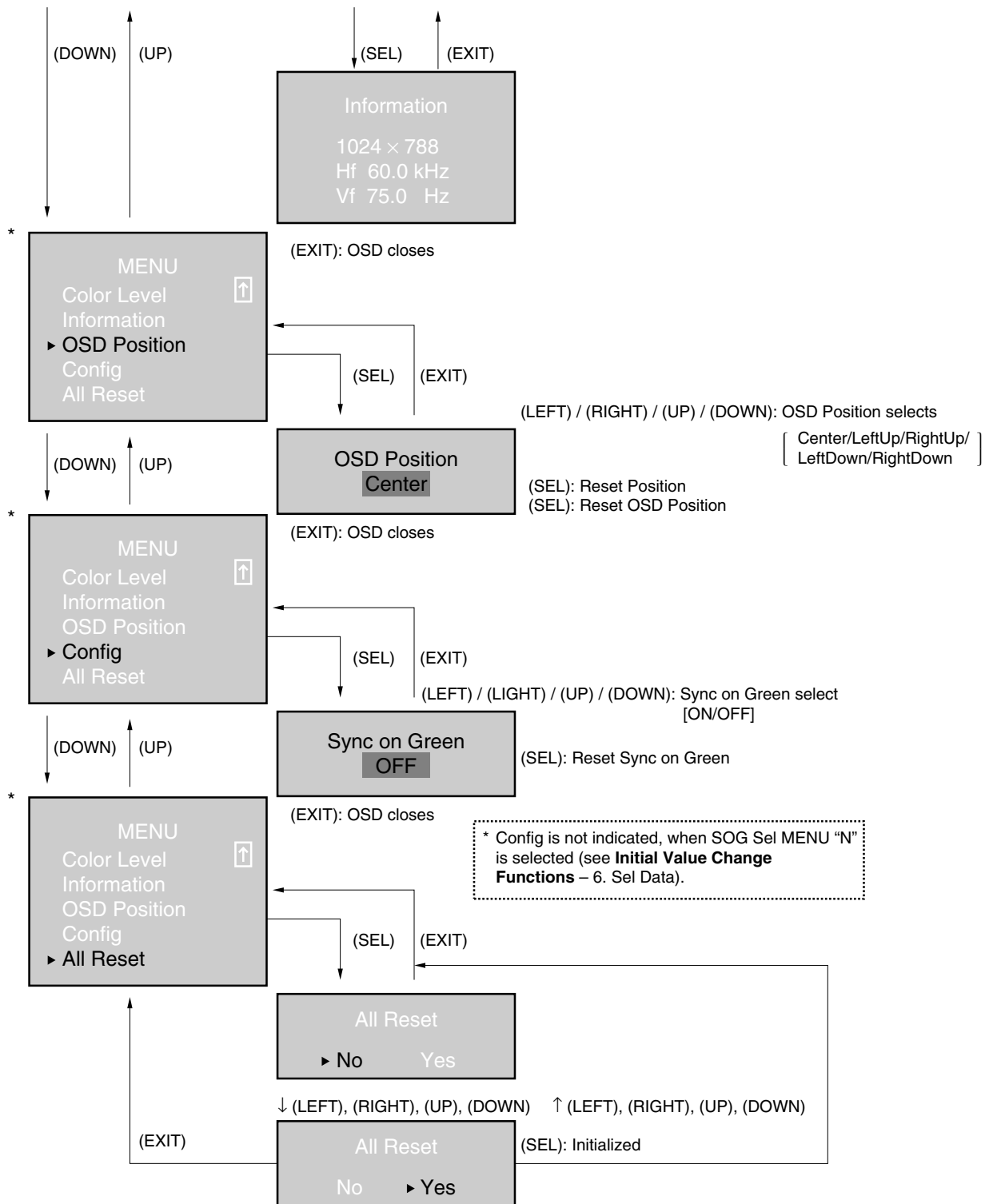

- Notes:**
1. The value of the selected signals of the LEFT, RIGHT, UP, and DOWN keys is continuously increased if the input signal is held for more than approximately one second. If it's held less than one second, the value is increased by one.
 2. The RESET signal initializes the value selected by the SEL key. The "All Reset" function initializes all the values adjusted before.
 3. No key input for more than ten seconds shall be regarded as "time out."
 4. Contrast W is synchronous with Contrast R, Contrast G, and Contrast B.
 5. Color Level W is synchronous with Color Level R, Color Level G, and Color Level B.

(c) Toggle type (SEL, UP, DOWN, and EXIT)

(UP), (DOWN): + or –
 (EXIT): Initialize

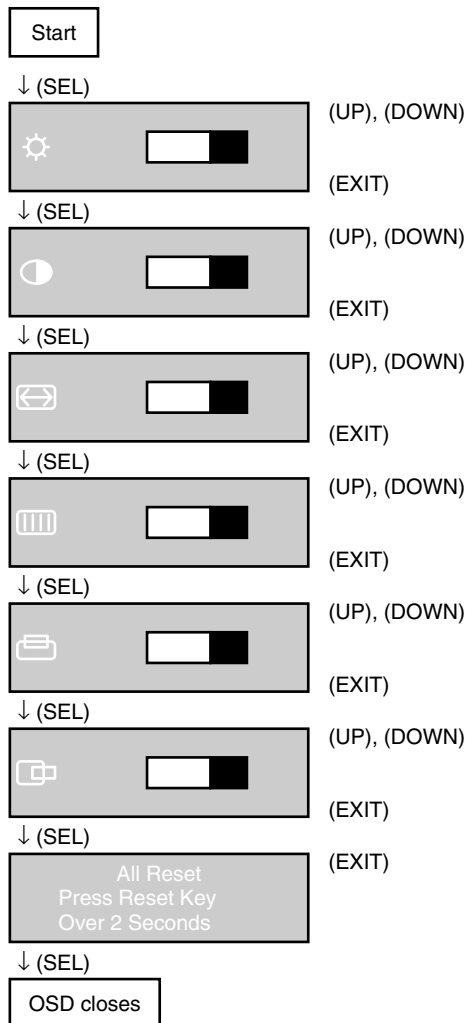

- Notes:**
1. The value of the signals selected by the UP and DOWN key is continuously increased if the input signal is held for more than about one second.
 2. The RESET signal initializes the value selected by the SEL key. The All Reset function initializes all the values adjusted before.
 3. No key input for more than five seconds shall be regarded as “time out.”
 4. EXIT is valid when connected to GND for more than approximately two seconds.

(6) Initial Value Change Functions

Initial value, OSD items, etc., can be changed.

The changed initial value becomes the initial value in each preset timing, and is applicable when it is reset (including All Reset).

- How to transpose to **initial value change mode**.
 Hierarchical type: Connect SET and UP to GND at the same time when the OSD function is in “information” mode.
 Toggle type: Connect SEL to GND while UP is connected to GND when the OSD function is in “All Reset” mode.

- Operation
 SEL, UP, DOWN, and EXIT

- How to return to normal mode
 Connect EXIT to GND or turn off the power supply when OSD is closed.
 Both LEDON and LEDOFF become “H” when this mode is operating.

No.	Form		Function Items
1	Compatible		It becomes valid when the toggle menu type only is selected. YES: Sync on Green The initial value of contrast (RGB synchronous) becomes 128. NO: No Sync on Green The initial value of contrast (RGB synchronous) becomes 100. The NEC factory value: NO.
2	Brightness		The maximum value of brightness of the backlight can be changed. Initial value: 100
3	Color Level		The initial value of the color level can be changed. Initial value: 128
4	Contrast		The initial value of contrast can be changed. Initial value: 128 (When NO is selected by Compatible in the toggle menu type, the initial value of RGB synchronous only is 100. As for RGB synchronous, the setup value described in this item becomes valid as the initial value regardless of the selection state of Compatible.)
5	LCD Data (Note 1)	Mode	Number of preset timings is displayed.
		HSE	The initial value of the Double Value can be changed.
		Delay	The value of the CLK delay can be changed. (Initial value cannot be changed.) Initial value: 0
		VD	The initial value of the updown position of the display position can be changed.
		HD	The initial value of the leftright position of the display position can be changed.
		Auto Adjust	Automatic adjustment
		Par. Delay (Note 2)	The compensation value of Delay of the auto adjust can be changed. Valid range: 0 to 255
		Par. HD (Note 3)	The compensation value of the horizontal position of the auto adjust can be changed. Valid range: 0 to 127

Continue to next page

No.	Form		Function Items
5	LCD Data	LCD Reset	The values set in No. 5 LCD Data return to the NEC factory settings.
6	Sel Data	S – Lvl Sel	The adjustment of each individual RGB can be made impossible by the adjustment of the color level. In this case, the adjustment item of each individual RGB is not displayed on the menu screen. ON: Individual adjustment is available. OFF: Individual adjustment is impossible. Initial value: ON.
		S – Cnt Sel	Adjustment for RGB independence can be made impossible by the adjustment of the color level. In this case, the adjustment for RGB independence is not displayed on the menu screen. ON: Individual adjustment is available. OFF: Individual adjustment is impossible Initial value: ON.
		SOG Sel	Select or nonselect of Sync on Green and display or nondisplay of the select menu can be selected. When nondisplay is selected, Config is not displayed. • FUNC (Y: Sync on Green selection) (N: Sync on Green nonselection) • MENU (Y: Select MENU display) (N: Select MENU nondisplay) Initial value (FUNC: Y; MENU: N) * This item becomes effective only when the hierarchical menu type is selected. It becomes invalid when the toggle menu type is selected.
		MENU Sel	B (blue) or S (transparency) can be selected for the background color of the OSD menu. Initial value: B
		Button Sel	4 (SEL, UP, DOWN, and EXIT) or 7 (SEL, UP, DOWN, RIGHT, LEFT, EXIT, and RESET) as the number of the adjustment switch can be selected. Initial value: 7
		PSOSD Sel	Display or no display for Power Save OSD can be selected. (For details, see page 29, Information Display by OSD) ON: Display OFF: No display Initial value: OFF
7	Information		Input signal information is displayed.
8	OSD Position		The initial value of the OSD display position can be changed. C: Center UL: Upper left UR: Upper right DL: Down left DR: Down right Initial value: C
9	Used Time		Used time in the normal and power save states is displayed. Used time is recorded every five minutes. But it is not recorded when the power supply is cut off within five minutes.
10	Full Reset		All values are returned to NEC factory settings. It takes about seven seconds.

Remark 1. The selected adjustment item is displayed with OSD.

Remark 2. All adjustment values are returned to the NEC factory value when menu type is changed.

Note 1. The values of No. 5 LCD Data are memorized in every preset timing.

Data except **Auto Adjust** of No. 5 LCD Data is saved when it is returned in the extreme upper menu. But it is not saved if the power supply is cut off halfway.

Note 2. Please sufficiently evaluate the compensation values that **Par. Delay** and **Par. HD** of No. 5 LCD Data need to set up, before determining the values.

(7) Information Display by OSD

- (a) Power save: The frequency of the horizontal and vertical synchronous signal is displayed for four seconds at a Power Save mode switchover.

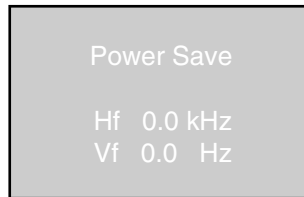

am

* It is displayed when the horizontal synchronous signal frequency (Hf) and vertical synchronous signal frequency (Vf) are as follows:

- (1) $Hf < 10 \text{ KHz}$
- (2) $Vf < 40 \text{ Hz}$
- (3) (1) and (2)

* It is not displayed when the "Power Save OSD no display" form is selected (see page 27, **Initial Value Change Functions** – 6. Sel Data, PSOSD Sel).

- (b) Out of Range: Each frequency is displayed for four seconds when the horizontal and vertical synchronous signal outside the corresponding range is input.

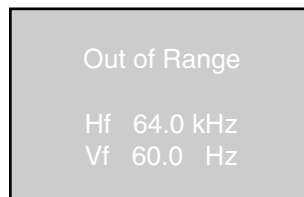

* It is displayed when the horizontal synchronous signal frequency (Hf) and vertical synchronous signal frequency (Vf) are as follows:

- (1) $10 \text{ KHz} \leq Hf < 23 \text{ KHz}$ or $61.5 \text{ KHz} < Hf$
- (2) $40 \text{ Hz} \leq Vf < 50 \text{ Hz}$ or $200 \text{ Hz} < Vf$
- (3) (1) and (2)

It is not displayed when either Hf or Vf is in Power Save mode.

* Display or no display for Out of Range cannot be selected.

- (c) Disable: It is displayed for four seconds if the switch for adjustment is Disable.

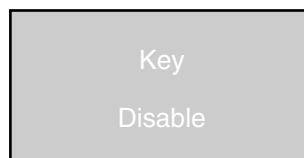

(8) Input Signal And Display Position — XGA Standard Timing

Pixels

D (0, 0)	D (0, 1)	D (0, 2)	D (1023, 0)
D (1, 0)	D (1, 1)	D (1, 2)	D (1, 1023)
D (2, 0)	D (2, 1)	D (2, 2)	D (1023, 2)
•	•	•			•
•	•	•			•
•	•	•			•
•	•	•			•
D (0, 767)	D (1, 767)	D (2, 767)	D (1023, 767)

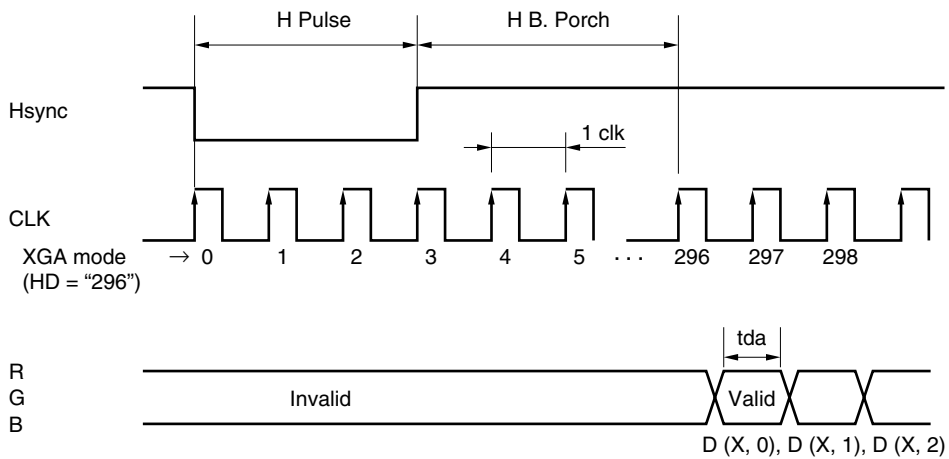
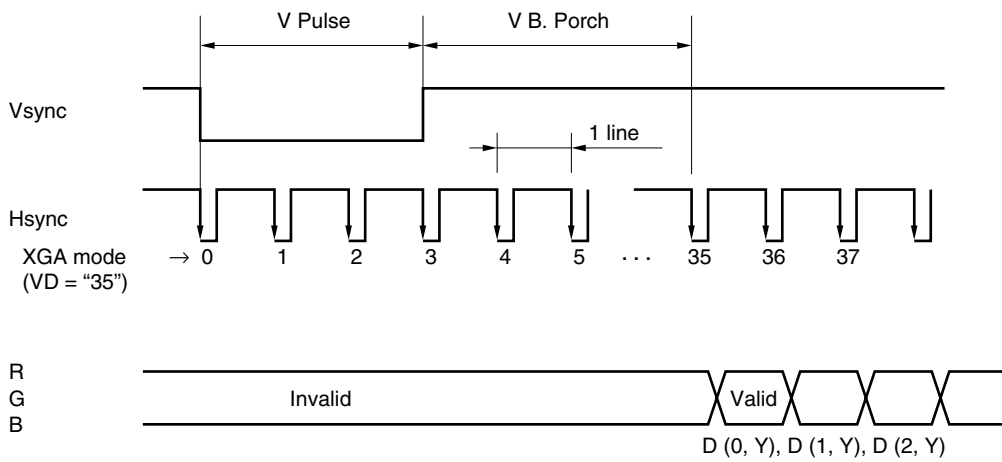

Note: The tda should be more than 4 ns.

OPTICAL CHARACTERISTICS

(Ta = 25°C, VDD = 12 V, VDDB = 12 V, Note 1)

Item	Symbol	Condition	Min.	Typ.	Max.	Unit	Remark
Contrast ratio	CR	$\gamma = 2.2$ viewing angle $\theta R = 0^\circ, \theta L = 0^\circ, \theta D = 0^\circ$, White/Black, at center	80	150	–	–	Note 2
Luminance	Lumax	White, at center	150	200	–	cd/m ²	Note 3
Luminance uniformity	–	White	–	–	1.30	–	Note 4

Reference data

(Ta = 25°C, VDD = 12 V, VDDB = 12 V, Note 1)

Item	Symbol	Condition	Min.	Typ.	Max.	Unit	Remark
Contrast ratio	CR	Best contrast angle $\theta R = 0^\circ, \theta L = 0^\circ, \theta D = 5^\circ$ White/Black, at center	–	300	–	–	Note 2
Color gamut	C	$\theta R = 0^\circ, \theta L = 0^\circ, \theta U = 0^\circ, \theta D = 0^\circ$ at center, to NTSC	35	40	–	%	–
Viewing angle range	θR	CR > 10, $\theta U = 0^\circ, \theta D = 0^\circ$ White/Black, at center	40	50	–	deg.	Note 5
	θL		40	50	–	deg.	
	θU	CR > 10, $\theta R = 0^\circ, \theta L = 0^\circ$ White/Black, at center	15	20	–	deg.	
	θD		25	35	–	deg.	
Response time	Ton	White (100%) to Black (10%)	–	11	25	ms	Note 6
	Toff	Black (0%) to Black (90%)	–	40	80		
Luminance control range	–	Maximum luminance: 100% at center	–	30 to 100	–	%	–

Notes: 1. The luminance is measured after 20 minutes, with all pixels in white.
The typical value is measured after luminance saturation.
Display mode: VESA XGA-75 Hz
RGB input voltage: 0.7 V p-p
Contrast: Default

2. The contrast ratio is calculated by using the following formula.

$$\text{Contrast ratio (CR)} = \frac{\text{Luminance with all pixels in white}}{\text{Luminance with all pixels in black}}$$

3. The luminance is measured after the module has been working for 20 minutes, with all pixels in white. The typical value is measured after luminance saturation, more than one hour after burn-in. The timing is XGA standard mode, preset No. 14.

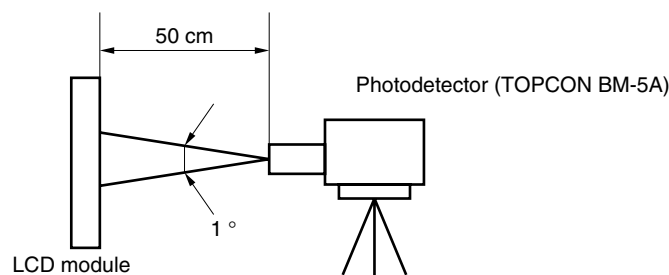

4. Luminance uniformity is calculated by using the following formula.

$$\text{Luminance uniformity} = \frac{\text{Maximum luminance}}{\text{Minimum luminance}}$$

The luminance is measured at or near the five points shown below.

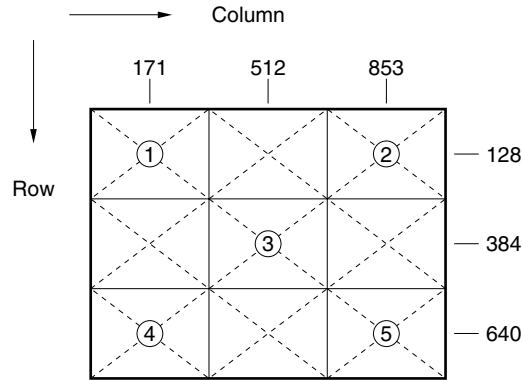

5. Definitions of viewing angles are as follows.

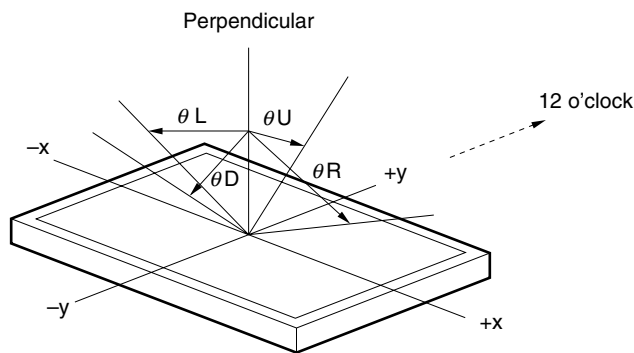

6. Definition of response time is as follows.

The photodetector output signal is measured when the luminance changes from white to black or from black to white.

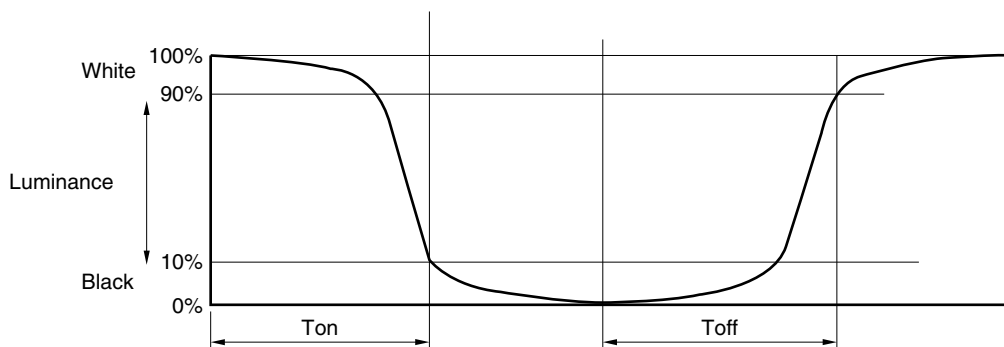

RELIABILITY TEST SPECIFICATIONS

Test Item	Test Condition	Notes
High temperature/humidity operation	50 ±2°C, 85% relative humidity 240 hours; display data is black.	Note 1
Heat cycle (operation)	<1> 0°C ±3°C ... 1 hour 55°C ±3°C ... 1 hour <2> 50 cycles, 4 hours/cycle <3> Display data is black.	Note 1
Thermal shock (nonoperation)	<1> -20°C ±3°C ... 30 minutes 60°C ±3°C ... 30 minutes <2> 100 cycles <3> Temperature transition time is within 5 minutes.	Note 1
Vibration (nonoperation)	<1> 5-100 Hz, 19.6 m/s ² (2G) 1 minute/cycle, X, Y, Z direction <2> 50 times each direction	Notes 1, 2
Mechanical shock (nonoperation)	<1> 294 m/s ² (30G), 11 ms X, Y, Z direction <2> 3 times each direction	Notes 1, 2
ESD (operation)	150 pF, 150 Ω, ±10 KV 9 places on a panel 10 times each place at one-second intervals	Note 1 Note 3
Dust (operation)	15 kinds of dust (JIS-Z 8901) Hourly 15 seconds stir, 8 times repeat	Note 1

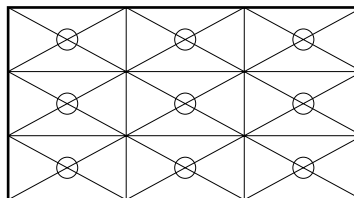

- Notes: 1. Display function is checked by the same condition as the LCD module outgoing inspection.
 2. Physical damage.
 3. Discharge points are shown in the following figure.



GENERAL CAUTIONS

Because the following figures and statements are very important, please be sure you understand their contents completely.

	CAUTION	This figure is a warning that you will get hurt and/or the module will be damaged if you make a mistake in operation.
---	----------------	---

	This figure is a warning that you will get an electric shock if you make a mistake in operation.	
	This figure is a warning that you will get hurt if you make a mistake in operation.	

 **CAUTION**

	Do not touch an inverter — on which there is a caution label — while the LCD module is in operation, because of dangerous high voltage.
---	---

(1) Caution when taking out the module

Pickup the pouch only, when removing the module from a carrier box.

(2) Cautions for handling the module

- a) As the electrostatic discharges may break the LCD module, handle the LCD module with care against electrostatic discharges.
- b)  As the LCD panel and backlight element are made from fragile glass material, impulse and pressure to the LCD module should be avoided.
- c) As the surface of polarizer is very soft and easily scratched, use a soft dry cloth without chemicals for cleaning.
- d) Do not pull the interface connectors in or out while the LCD module is operating.
- e) Put the module display side down on a flat horizontal plane.
- f) Handle connectors and cables with care.
- g) When the module is operating, do not lose CLK, HS or Vsync signal. If any one of these signals is lost, the LCD panel would be damaged.
- h) The torque to mounting screw should never exceed 0.392 N·m (4 kgf·cm).

(3) Cautions regarding atmosphere

- a) Dew-drop atmosphere should be avoided.
- b) Do not store and/or operate the LCD module in a high-temperature and/or high-humidity atmosphere. Storage in an electro-conductive polymer packing pouch and in a relatively low-temperature atmosphere is recommended.
- c) This module uses cold cathode fluorescent lamps. The lifetime of the lamps is shortened conspicuously at low temperatures.
- d) Do not operate the LCD module in a high magnetic field.

(4) Cautions about the module characteristics

- a) Do not apply a fixed pattern for a long time to the LCD module at product aging. Applying a fixed pattern for a long time may cause image sticking.

(5) Other cautions

- a) Do not disassemble and/or reassemble the LCD module.
- b) Do not readjust any variable resistors, switches, etc.
- c) When returning the module for repair, etc., please pack the module so it will not be broken. We recommend using the original shipping packages.

The liquid crystal display has the following specific characteristics. These are neither defects nor malfunctions.

The display condition of the LCD module may be affected by the ambient temperature.

The LCD module has cold cathode tube for backlight. Optical characteristics, like luminance or uniformity, will change over time.

Uneven brightness and/or small spots may be noticed, depending on different display patterns.

OUTLINE DRAWINGS

Front View (Unit: mm)

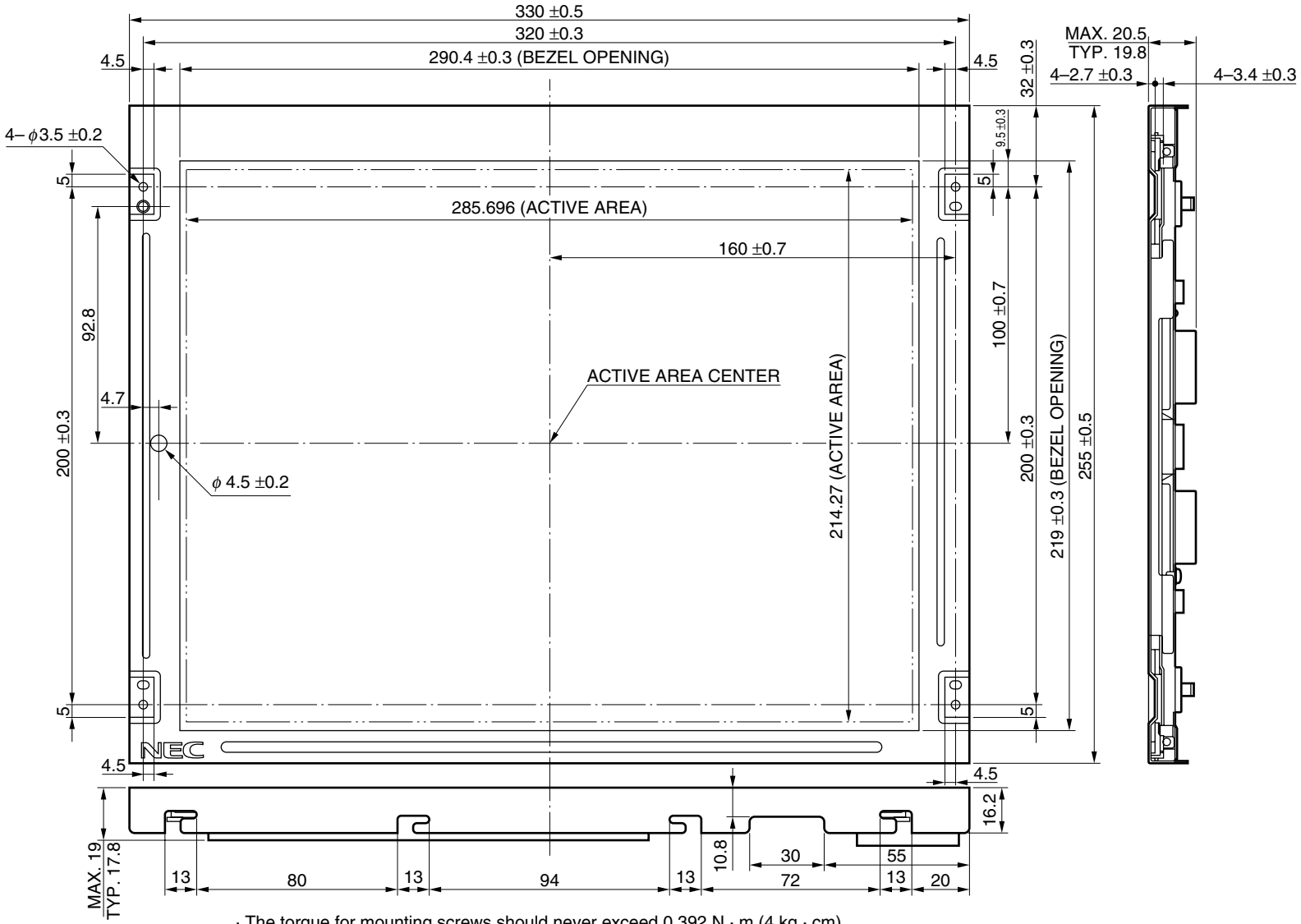

- The torque for mounting screws should never exceed $0.392 \text{ N} \cdot \text{m}$ ($4 \text{ kg} \cdot \text{cm}$).
- Tolerance of dimensions not shown is $\pm 0.5 \text{ mm}$.

Rear View (Unit: mm)

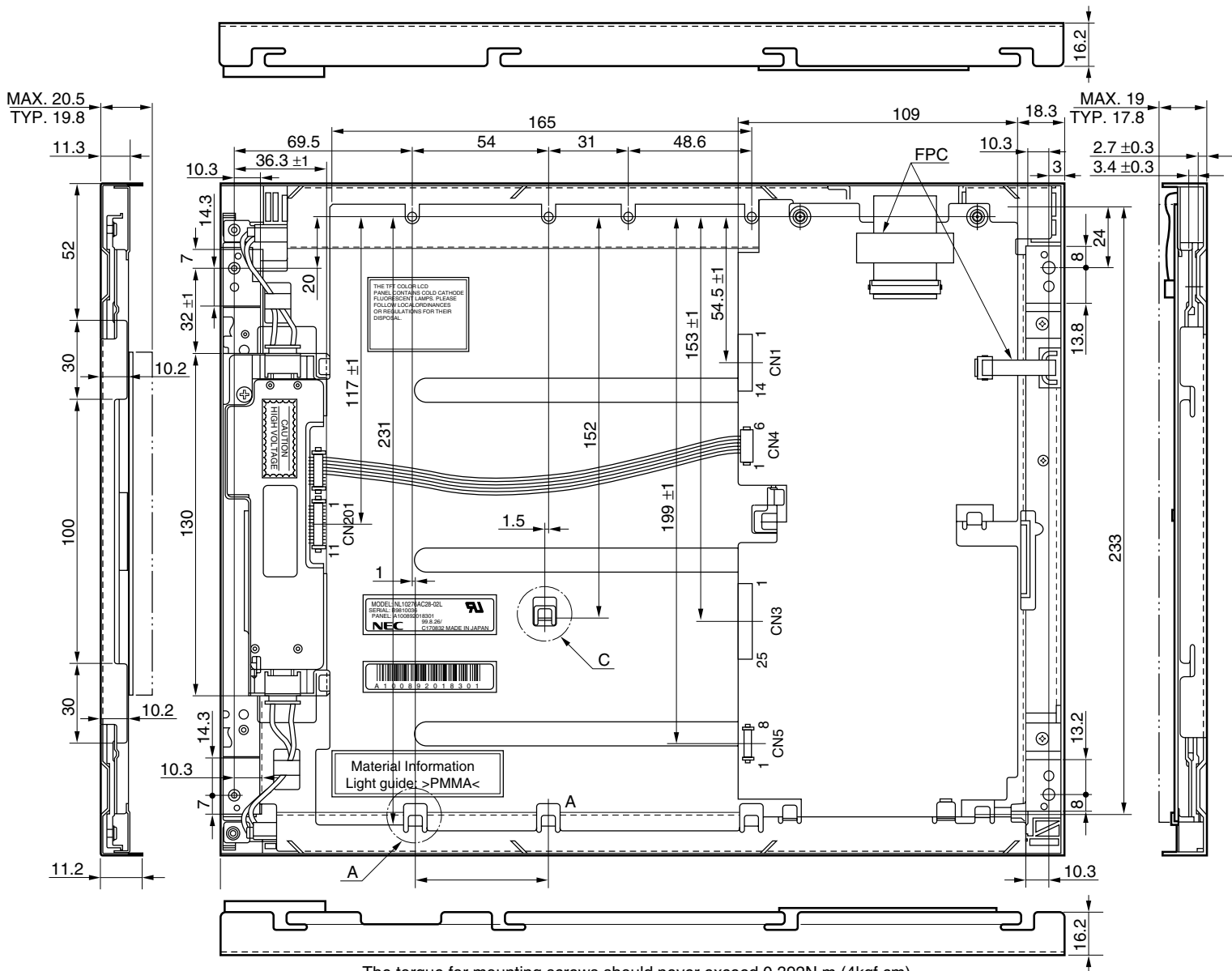

- The torque for mounting screws should never exceed 0.392N·m (4kgf·cm)
- Tolerance of dimensions not shown is ±0.5 mm.

[MEMO]

[MEMO]

No part of this document may be copied or reproduced in any form or by any means without the prior written consent of NEC Corporation. NEC Corporation assumes no responsibility for any errors which may appear in this document.

NEC Corporation does not assume any liability for infringement of patents, copyrights or other intellectual property rights of third parties by or arising from use of a device described herein or any other liability arising from use of such device. No license, either express, implied or otherwise, is granted under any patents, copyrights or other intellectual property rights of NEC Corporation or others.

While NEC Corporation has been making continuous effort to enhance the reliability of its electronic components, the possibility of defects cannot be eliminated entirely. To minimize risks of damage or injury to persons or property arising from a defect in an NEC electronic component, customers must incorporate sufficient safety measures in its design, such as redundancy, fire-containment, and anti-failure features. NEC devices are classified into the following three quality grades:

"Standard," "Special," and "Specific". The Specific quality grade applies only to devices developed based on a customer designated "quality assurance program" for a specific application. The recommended applications of a device depend on its quality grade, as indicated below. Customers must check the quality grade of each device before using it in a particular application.

Standard: Computers, office equipment, communications equipment, test and measurement equipment, audio and visual equipment, home electronic appliances, machine tools, personal electronic equipment and industrial robots

Special: Transportation equipment (automobiles, trains, ships, etc.), traffic control systems, anti-disaster systems, anti-crime systems, safety equipment and medical equipment (not specifically designed for life support)

Specific: Aircrafts, aerospace equipment, submersible repeaters, nuclear reactor control systems, life support systems or medical equipment for life support, etc.

The quality grade of NEC devices is "Standard" unless otherwise specified in NEC's Data Sheets or Data Books. If customers intend to use NEC devices for applications other than those specified for Standard quality grade, they should contact an NEC sales representative in advance.

(Note)

- (1) "NEC" as used in this statement means NEC Corporation and also includes its majority-owned subsidiaries.
- (2) "NEC electronic component products" means any electronic component product developed or manufactured by or for NEC (as defined above).